

OWNERS MANUAL

1 Installing the software

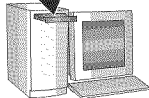

Before connecting any cables, install the software that was included with your camera. Follow the on-screen instructions.



After installing the software, return to this User guide.

2 Loading the KLIC-7001 battery

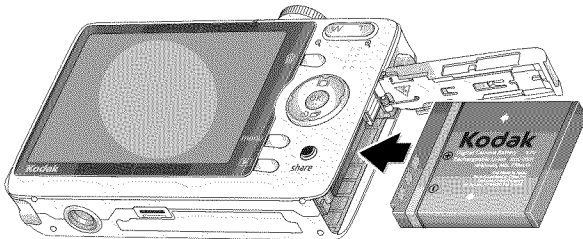

Kodak Li-Ion
rechargeable
digital camera
battery KLIC 7001

3 Charging the KLIC-7001 battery

Kodak USB AC adapter

(included)

Learn more at:

www.kodak.com/go/USBcharging.

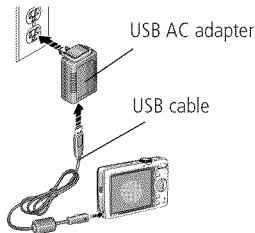

Battery
Charging
light

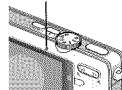

First, turn
OFF the
camera.

Kodak EasyShare camera or printer docks

(may be sold separately)

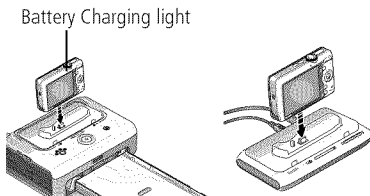

Charge
until the
Battery
Charging
light turns
off (up to 3
hours).

Kodak 5V AC adapter, Kodak Li-Ion universal battery chargers

(sold separately)

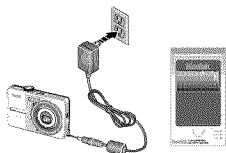

Purchase
accessories:
[www.kodak.com/
go/accessories](http://www.kodak.com/go/accessories).

Your computer

Connect the USB cable to the computer's USB port, not a Hub.
Make sure the computer is turned on and not in sleep mode.

4 Turning on the camera

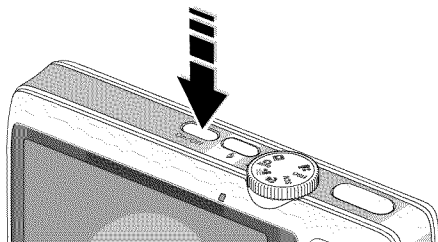

5 Setting the language, date/time

- Language:
- ① ▲/▼ to change.
 - ② OK to accept.
- Date/Time:
- ① At the prompt, press OK.
 - ② ▲/▼ to change.
◀/▶ for previous/next field.
OK to accept.

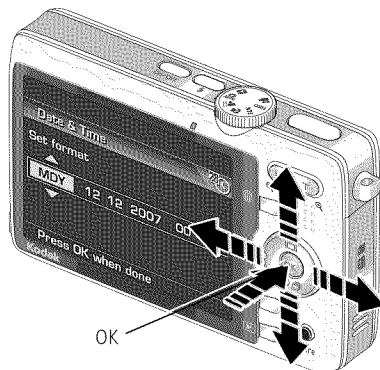

6 Taking a picture/video

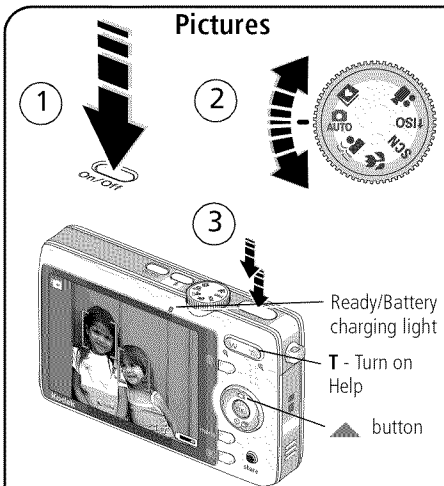

Press the Shutter button halfway to focus and set exposure.

Press it completely down when the Ready light turns green.

Press ▲ to turn on/off:

- Status icons
- Framing grid

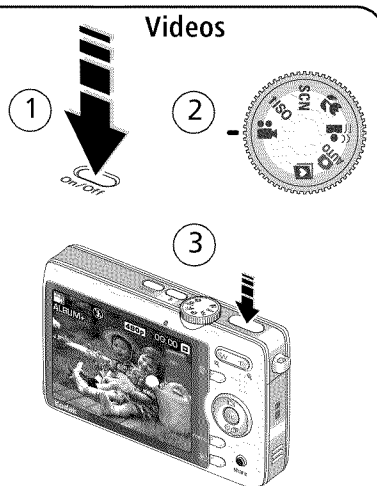

Press the Shutter button completely down and release.

To stop recording, press the Shutter button again.

7 Reviewing pictures/videos

Camera

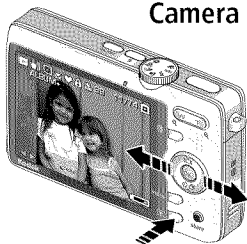

- ① Press Review.
- ② ◀/▶ for previous/next picture/video.

Videos

▼ Play.

During playback:

OK pause/unpause.

▲/▼ adjust the volume.

▶ play at 2X speed; press again for 4X.

◀ reverse at 2X speed; press again for 4X.

Your television

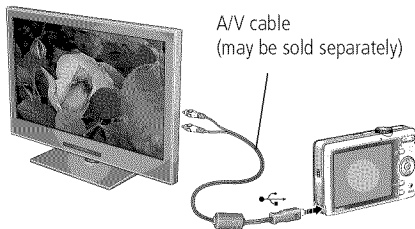

- ① Turn off the camera.
- ② Connect the A/V cable.
- ③ Turn on the camera.
- ④ Review pictures/videos/slide shows on television.

Other display devices:

- Your computer monitor
- Devices equipped with a video input

8 Transferring pictures/videos

USB cable

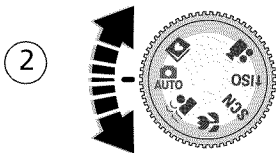
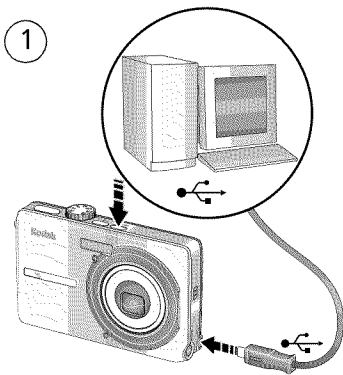

Kodak EasyShare printer dock or camera dock

(May be sold separately.)

For dock compatibility, visit www.kodak.com/go/dockcompatibility.

To purchase accessories, visit www.kodak.com/go/m763accessories, www.kodak.com/go/m863accessories, www.kodak.com/go/md863accessories.

To use an EasyShare dock, see its User guide.

9

Keep learning about your camera!

Congratulations!

You have:

- set up your camera
- taken pictures
- transferred pictures to your computer

Keep learning!

Finish reading this book, so you can take and share your best pictures!

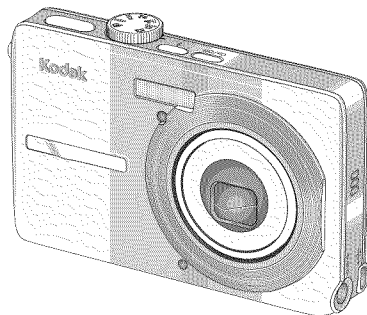

Visit www.kodak.com/go/m763support, [m863support](http://www.kodak.com/go/m863support), or [md863support](http://www.kodak.com/go/md863support) and www.kodak.com/go/easyssharecenter for:

- the Extended user guide
- interactive troubleshooting and repairs
- interactive tutorials
- FAQs
- downloads
- accessories
- printing information
- product registration

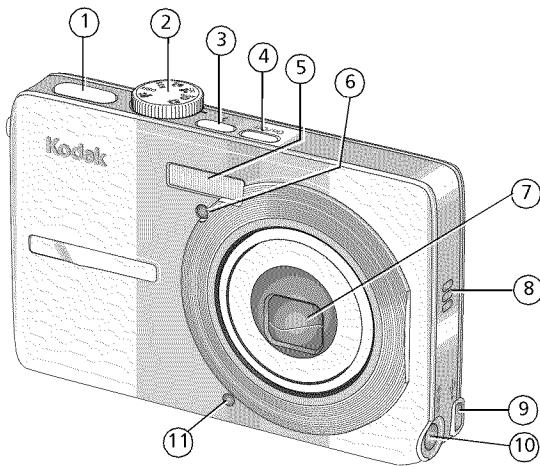

Front view



- | | | | |
|---|------------------------|----|---|
| 1 | Shutter button | 7 | Lens |
| 2 | Mode dial | 8 | Speaker |
| 3 | Flash button | 9 | USB  |
| 4 | On/Off button | 10 | DC-In (5V)  for optional AC adapter |
| 5 | Flash | 11 | Microphone |
| 6 | Self-timer/video light | | |

Back view

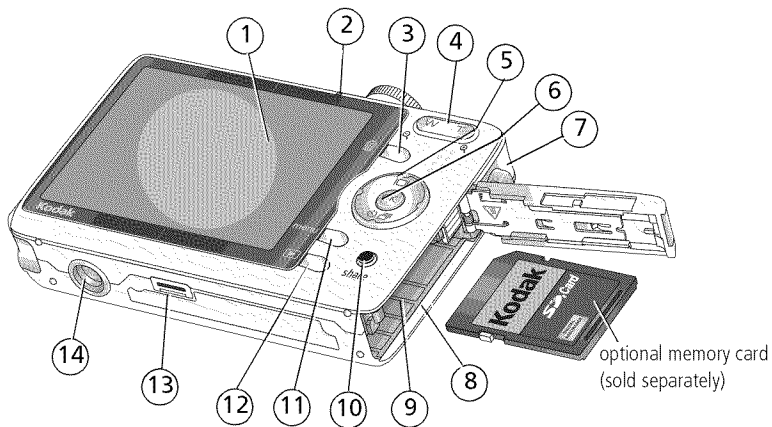

- | | | | |
|---|---|----|-----------------------------|
| 1 | LCD | 8 | SD or SDHC memory card slot |
| 2 | Ready/Battery charging light | 9 | Battery compartment |
| 3 | Delete button | 10 | Share button |
| 4 | Zoom button (Wide/Telephoto) | 11 | Menu button |
| 5 |  | 12 | Review button |
| 6 | OK button | 13 | Dock connector |
| 7 | Strap post | 14 | Tripod socket |

1

Doing more with your camera

Using optical zoom

Use optical zoom to get up to 3X closer to your subject.

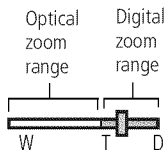
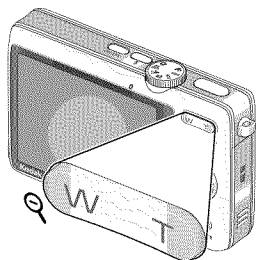

- 1 Use the LCD to frame your subject.
- 2 Press Telephoto (T) to zoom in. Press Wide Angle (W) to zoom out.

The zoom indicator shows zoom status.

- 3 Take the picture or video.
 - Always use the auto focus framing marks.
 - If you are not using zoom (1X, wide angle), you can be as close as 13.8 in. (35 cm) to your subject.
 - As you zoom, you need to move further from your subject.



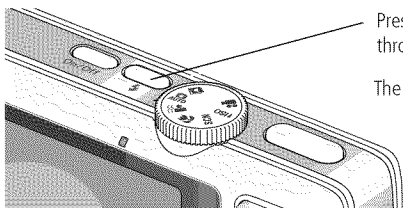

Using the flash

Use the flash when you take pictures at night, indoors, or outdoors in heavy shadows.



Press the  button repeatedly to scroll through flash modes (see Flash modes below).





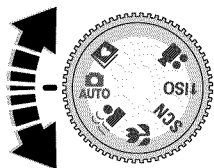

The current flash mode appears in the LCD screen.

Flash modes	Flash fires	
 Auto Flash	When the lighting conditions require it.	
 Off	Never.	
 Fill	Every time you take a picture, regardless of the lighting conditions. Use when the subject is in shadow or is "backlit" (when the light is behind the subject). In low light, hold the camera steady or use a tripod.	
 Red-eye	If Red-eye Pre-flash is turned off:	If Red-eye Pre-flash is turned on:
	<ul style="list-style-type: none"> ■ The flash fires once and the camera automatically corrects red-eye in the picture. 	<ul style="list-style-type: none"> ■ The flash fires once so the eyes become accustomed to the flash, then fires again when the picture is taken.

Using different picture-taking modes



Choose the mode that best suits your subjects and surroundings.

Use this mode	For
 Auto AUTO	General picture taking—offers an excellent balance of image quality and ease of use.
 Digital Image Stabilization	Minimizing the effects of camera shake and subject movement.
 Close-up	Close range. Use available light instead of flash if possible.
SCN Scene	Point-and-shoot simplicity when taking pictures under special conditions. (See page 13.)
 High ISO	People in low-light scenes indoors using a higher ISO.
 Video	Capturing video with sound. (See page 4.)
 Favorites	Reviewing favorite pictures.

Scene modes

Choose a Scene mode—for great pictures in practically any situation!

- 1 Turn the Mode dial to Scene **SCN**.
- 2 Press **◀/▶** to display Scene mode descriptions.
If the mode description turns off before you finish reading it, press OK.
- 3 Press OK to choose a Scene mode.

Using camera Help

To better understand each menu option, use camera Help. Select an option you want to learn more about, then press the Zoom telephoto (T) button.

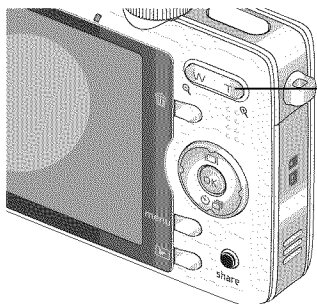

T Turn on Help

▲/▼ Scroll up/down

OK Turn off Help

Taking panoramic pictures

Use panorama to “stitch” up to 3 pictures into a panoramic scene.

- 1 Turn the Mode dial to SCN.
- 2 Press **◀/▶** on the 4-way button to highlight Panorama Left-Right or Panorama Right-Left (depending on the direction you want to pan), then press the OK button.
- 3 Take the first picture.

After a quickview, the LCD displays the liveview and an “overlay” from the first picture.

- 4 Compose the second picture. Make the overlay from the first picture cover the same portion in the new picture. (You can press the Delete button to re-take a picture.)
- 5 If you are taking only 2 pictures, press the OK button to stitch them together.

*After you take 3 pictures, the pictures are automatically stitched together.
The LCD displays a quickview for approximately 5 seconds.*

Take 2 or 3 pictures.

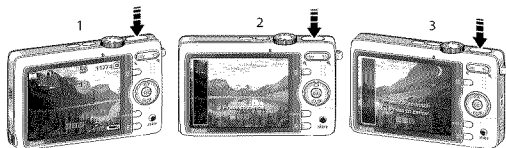

Get 1 panoramic picture.



Understanding picture-taking icons

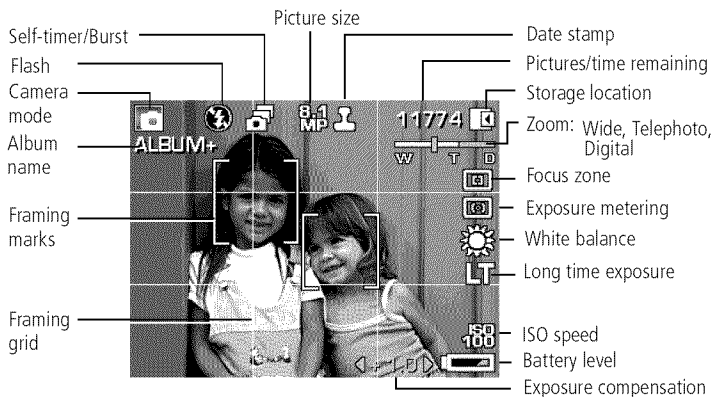

2

Working with pictures/videos

Magnifying pictures

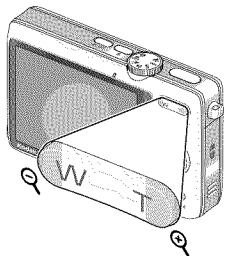

- 1 Press the Review button.
- 2 Press W/T to magnify 2X–8X.
- 3 Press / / to view other parts of the picture.
- 4 Press OK to return to 1X.

Cropping pictures

You can crop a picture so that only the desired portion of the picture remains.

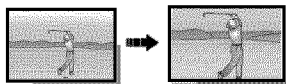

Picture

Cropped picture

- 1 Press the Review button, then / to find a picture.
- 2 Press the Menu button. Press / to find Edit.
- 3 Press / to highlight Crop, then press OK.
- 4 Press Telephoto (T) to zoom in, or / / to move the crop box. Press OK.
- 5 Follow the screen prompts.

Using sound tags

You can add a unique sound/message (up to 1 minute long) to your picture (not to videos).

Recording a sound tag



- 1 Press the Review button, then to find a picture.
- 2 Press the Menu button, then to highlight Sound Tag. Press the OK button.
- 3 Choose Record, then press OK.
- 4 Follow the screen prompts.

The sound tag is applied to your picture.

Playing a sound tag

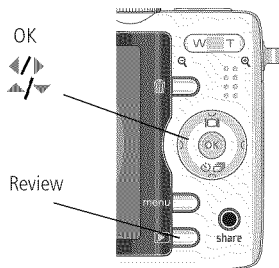

- 1 Press the Review button, then to find a tagged picture.
- 2 Press to play the sound tag.
- 3 Press to adjust the volume.
- 4 Press OK to pause or replay the sound tag during playback.

Viewing thumbnails (multi-up)





- 1 Press the Review button.
- 2 Press the Zoom Wide Angle (W) button to change from single-picture view to multi-up thumbnails.
- 3 Press Telephoto (T) to return to single-picture view.
 - To select multiple pictures/videos, see page 21.

Using Kodak Perfect Touch technology

Kodak Perfect Touch technology helps ensure better, brighter pictures.

- 1 Press the Review button, then   for previous/next picture.
- 2 Press the Menu button. Press   to find Edit.
- 3 Press   to highlight Perfect Touch tech., then press OK.

The enhancement is previewed in a split screen. Press   to view other parts of the picture.

- 4 Press OK. Follow the screen prompts to replace the original picture or to save the enhanced picture as a new one.

NOTE: You cannot enhance previously enhanced pictures.

Editing videos

Making a picture from a video

You can choose a single frame from a video, then make a picture suitable for printing.

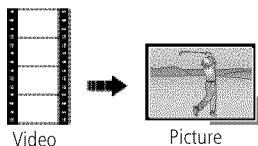

- 1 Press the Review button, then $\blacktriangleleft/\blacktriangleright$ to find a video.
- 2 Press the Menu button. Press $\blacktriangleleft/\blacktriangleright$ to find Edit.
- 3 Press $\blacktriangleup/\blacktriangledown$ to highlight Make Picture, then press OK.
- 4 Press \blacktriangledown to select a video frame.
- 5 Follow the screen prompts to save the picture.

Trimming a video

You can delete an unwanted portion from the beginning or end of a video.

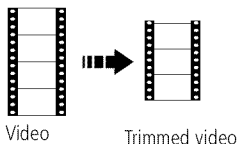



- 1 Press the Review button, then $\blacktriangleleft/\blacktriangleright$ to find a video.
- 2 Press the Menu button. Press $\blacktriangleleft/\blacktriangleright$ to find Edit.
- 3 Press $\blacktriangleup/\blacktriangledown$ to highlight Trim, then press \blacktriangledown .
- 4 Follow the screen prompts. (Use fast-forward and fast-reverse, if needed.)

Making a video action print

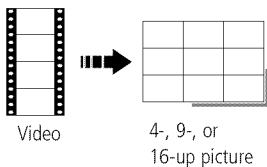
From a video, you can make a 4-, 9-, or 16-up picture, suitable for a 4 x 6-inch (10 x 15 cm) print.



- 1 Press the Review button, then  to find a video.
- 2 Press the Menu button. Press  to highlight Edit Video, then press OK.
- 3 Press  to highlight Video Action Print, then press OK.



- 4 Choose an option, then press OK.

Auto options: The camera includes the first and last frames, then 2, 7, or 14 equally spaced frames.

Manual options: You choose the first and last frames; the camera chooses 2, 7, or 14 equally spaced frames.

Running a slide show

Use Slide Show to display your pictures/videos on the camera, a television, or any device equipped with a video input (see page 5).

- 1 Press the Review button, then the Menu button.
- 2 Press   to highlight Slide Show, then press the OK button.
- 3 Press  to highlight Begin Show, then press the OK button.

To interrupt the Slide Show, press the OK button.

Running a multimedia slide show

Multimedia Slide Show is similar to Slide Show, but also offers music and visual effects. First, select 2-20 pictures (see page 21). Then:

- 1 Press the Review button.
- 2 Press **▲/▼** to highlight Multimedia Slide Show, then press the OK button.
- 3 Press **▲/▼** to highlight a choice from the menu, then press the OK button.

Selecting multiple pictures/videos

Use the multi-select feature when you have two or more pictures/videos to print, transfer, delete, etc. (Multi-select is used most effectively in Multi-Up mode, page 18.)

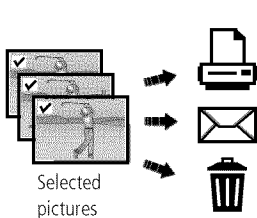

- 1 Press the Review button, then **◀/▶** to find a picture/video.
- 2 Press the OK button to select pictures/videos.

A check mark appears on the picture. You can now print, transfer, or delete the selected pictures. You can press OK a second time to remove a check mark.

Deleting pictures/videos

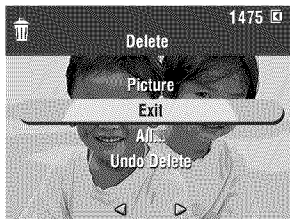

- 1 Press the Review button.
- 2 Press ◀/▶ for previous/next picture/video.
- 3 Press the Delete button.
- 4 Follow the screen prompts.

NOTE: After you delete a picture, the next picture (overlaid with the Delete menu with the Undo Delete option) appears. If there are no more pictures, the Delete menu on a blank screen appears. See Using the undo delete feature for more information.

Using the undo delete feature

If you accidentally delete a picture, use Undo Delete to retrieve it. This feature is available only immediately after you delete a picture in Review mode. The Undo Delete option appears.

- 1 Press ▲/▼ to highlight Undo Delete.
- 2 Press OK.

The deleted picture (overlaid with the Delete menu) appears.

3

Solving camera problems

For support, visit www.kodak.com/go/m763support, www.kodak.com/go/m863support, www.kodak.com/go/md863support and select Interactive Troubleshooting & Repairs.

Camera problems

If...	Try one or more of the following
Camera does not turn on/off.	<ul style="list-style-type: none"> ■ Remove the battery, then reinsert correctly (see page 1). ■ Install new battery. ■ Charge rechargeable battery (see page 2).
Camera does not recognize SD card.	<ul style="list-style-type: none"> ■ Purchase a certified SD/SDHC card. ■ Reformat the card. <p>Caution: Formatting a card deletes all pictures and videos, including protected files.</p> <ul style="list-style-type: none"> ■ Insert a card into the slot, then push to seat.
Short battery life with Kodak Li-Ion rechargeable digital camera battery KLIC-7001.	<ul style="list-style-type: none"> ■ Limit the following activities that quickly deplete battery power: reviewing pictures/videos on the LCD; excessive use of the flash.
Battery does not charge using USB charging.	<ul style="list-style-type: none"> ■ See page 2 or visit www.kodak.com/go/usbcharging.

Important safety instructions



CAUTION:

Do not disassemble this product; there are no user-serviceable parts inside. Refer servicing to qualified service personnel. Do not expose this product to liquid, moisture, or extreme temperatures. Kodak AC adapters and battery chargers are intended for indoor use only. The use of controls, adjustments, or procedures other than those specified herein may result in exposure to shock and/or electrical or mechanical hazards. If the LCD breaks, do not touch the glass or liquid. Contact Kodak customer support.

- The use of an accessory that is not recommended by Kodak may cause fire, electric shock, or injury.
- Use only a USB-certified computer. Contact your computer manufacturer if you have questions.
- If using this product in an airplane, observe all instructions of the airline.
- When removing the battery, allow it to cool; it may be hot.
- Read and follow all warnings and instructions supplied by the battery manufacturer.
- Use only batteries approved for this product to avoid risk of explosion.
- Keep batteries out of the reach of children.
- Do not allow batteries to touch metal objects, including coins. Otherwise, a battery may short circuit, discharge energy, become hot, or leak.
- Do not disassemble, install backward, or expose batteries to liquid, moisture, fire, or extreme temperature.
- Remove the battery when the product is stored for an extended period of time. In the unlikely event that battery fluid leaks inside the product, contact Kodak customer support.
- In the unlikely event that battery fluid leaks onto your skin, wash immediately with water and contact your local health provider. For additional health-related information, contact your local Kodak customer support.
- Dispose of batteries according to local and national regulations.
- Do not charge non-rechargeable batteries.

For more information on batteries, see www.kodak.com/go/batterytupes

Upgrading your software and firmware

Download the latest versions of the software included on the Kodak EasyShare software CD and the camera firmware (the software that runs on the camera). See www.kodak.com/go/m763downloads, www.kodak.com/go/m863downloads, or www.kodak.com/go/md863downloads.

Additional care and maintenance

- If the camera has been subjected to inclement weather or you suspect water has gotten inside the camera, turn off the camera and remove the batteries and card. Allow components to air-dry for at least 24 hours before using the camera again.
- Blow gently on the lens or LCD to remove dust and dirt. Wipe gently with a soft, lint-free cloth or an untreated lens-cleaning tissue. Do not use cleaning solutions unless designed specifically for camera lenses. Do not allow chemicals, such as suntan lotion, to contact painted surfaces.
- Service agreements are available in some countries. Contact a dealer of Kodak products for more information.

For digital camera disposal or recycling information, contact your local authorities. In the US, visit the Electronics Industry Alliance Web site at www.eiae.org or visit www.kodak.com/go/m763support, www.kodak.com/go/m863support, or www.kodak.com/go/md863support.

Warranty

Kodak warrants Kodak consumer electronic products and accessories (“Products”), excluding batteries, to be free from malfunctions and defects in both materials and workmanship for one year from the date of purchase. Retain the original dated sales receipt. Proof of the date of purchase will be required with any request for warranty repair.

Limited warranty coverage

Warranty service is only available from within the country where the Products were originally purchased. You may be required to ship Products, at your expense, to the authorized service facility for the country where the Products were purchased. Kodak will repair or replace Products if they fail to function properly during the warranty period, subject to any conditions and/or limitations stated herein. Warranty service will include all labor as well as any necessary adjustments and/or replacement parts. If Kodak is unable to repair or replace a Product, Kodak will, at its option, refund the purchase price paid for the Product provided the Product has been returned to Kodak along with proof of the purchase price paid. Repair, replacement, or refund of the purchase price are the sole remedies under the warranty. If replacement parts are used in making repairs, those parts may

be remanufactured, or may contain remanufactured materials. If it is necessary to replace the entire Product, it may be replaced with a remanufactured Product. Remanufactured Products, parts and materials are warranted for the remaining warranty term of the original Product, or 90 days after the date of repair or replacement, whichever is longer.

Limitations

This warranty does not cover circumstances beyond Kodak's control. This warranty does not apply when failure is due to shipping damage, accident, alteration, modification, unauthorized service, misuse, abuse, use with incompatible accessories or attachments (such as third party ink or ink tanks), failure to follow Kodak's operation, maintenance or repacking instructions, failure to use items supplied by Kodak (such as adapters and cables), or claims made after the duration of this warranty. Kodak makes no other express or implied warranty for this product, and disclaims the implied warranties of merchantability and fitness for a particular purpose. In the event that the exclusion of any implied warranty is ineffective under the law, the duration of the implied warranty will be one year from the purchase date or such longer period as required by law. The option of repair, replacement, or refund is Kodak's only obligation. Kodak will not be responsible for any special, consequential or incidental damages resulting from the sale, purchase, or use of this product regardless of the cause. Liability for any special, consequential or incidental damages (including but not limited to loss of revenue or profit, downtime costs, loss of the use of the equipment, cost of substitute equipment, facilities or services, or claims of your customers for such damages resulting from the purchase use or failure of the Product), regardless of cause or for breach of any written or implied warranty is expressly disclaimed.

Your rights

Some states or jurisdictions do not allow exclusion or limitation of incidental or consequential damages, so the above limitation or exclusion may not apply to you. Some states or jurisdictions do not allow limitations on how long an implied warranty lasts, so the above limitation may not apply to you. This warranty gives you specific rights, and you may have other rights which vary from state to state or by jurisdiction.

Outside the United States and Canada

In countries other than the United States and Canada, the terms and conditions of this warranty may be different. Unless a specific Kodak warranty is communicated to the purchaser in writing by a Kodak company, no warranty or liability exists beyond any minimum requirements imposed by law, even though defect, damage, or loss may be by negligence or other act.

FCC compliance and advisory



Kodak EasyShare M763/M863/MD863 digital camera

This equipment has been tested and found to comply with the limits for a Class B digital device, pursuant to Part 15 of the FCC Rules. These limits are designed to provide reasonable protection against harmful interference in a residential installation.

This equipment generates, uses, and can radiate radio frequency energy and, if not installed or used in accordance with the instructions, may cause harmful interference to radio communications. However, there is no guarantee that interference will not occur in a particular installation.

If this equipment does cause harmful interference to radio or television reception, which can be determined by turning the equipment off and on, the user is encouraged to try to correct the interference by one or more of the following measures: 1) reorient or relocate the receiving antenna; 2) increase the separation between the equipment and the receiver; 3) connect the equipment to an outlet on a circuit different from that to which the receiver is connected; 4) consult the dealer or an experienced radio/TV technician for additional suggestions.

Any changes or modifications not expressly approved by the party responsible for compliance could void the user's authority to operate the equipment. Where shielded interface cables have been provided with the product or specified additional components or accessories elsewhere defined to be used with the installation of the product, they must be used in order to ensure compliance with FCC regulation.

FCC and Industry Canada

This device complies with Industry Canada RSS-210 and FCC Rules. Operation is subject to the following two conditions: (1) this device may not cause harmful interference, and (2) this device must accept any interference received, including interference that may cause undesired operation.

FCC et Industrie Canada

Cet appareil est conforme à la norme RSS-210 d'Industrie Canada et aux réglementations de la FCC. Son utilisation est soumise aux deux conditions suivantes : (1) cet appareil ne doit pas provoquer d'interférences nuisibles, et (2) cet appareil doit supporter les interférences reçues, y compris celles susceptibles de nuire à son bon fonctionnement.

Canadian DOC statement

DOC Class B Compliance

This Class B digital apparatus complies with Canadian ICES-003.

Observation des normes-Classe B

Cet appareil numérique de la classe B est conforme à la norme NMB-003 du Canada.

Australian C-tick



N137

Waste Electrical and Electronic Equipment labeling



EU: It is the user's responsibility to discard this equipment into an approved, segregated collection scheme to enable its suitable treatment/disposal and to improve human/environmental protection. For more information, see your retailer, local authority or www.kodak.com/go/recycle. (Product weight: 125 g.)

VCCI Class B ITE

この装置は、情報処理装置等電波障害自主規制協議会（VCCI）の基準に基づいたクラスB情報技術装置です。この装置は、家庭環境で使用することを目的としています。この装置がラジオやテレビジョン受信機に近接して使用されると、電波障害を引き起こすことがあります。取扱説明書に従って正しい取り扱いをして下さい。

Korean Class B ITE

이 기기는 가정용으로 전자파결합등록된 기기로서 주거지역에서는 물론 모든 지역에서 사용할 수 있습니다.

China RoHS

环保使用期限 (EPUP)

在中国大陆, 该值表示产品中存在的任何危险物质不得释放, 以免危及人身健康、财产或环境的时间期限(以年计)。该值根据操作说明中所规定的产品正常使用而定。

有毒有害物质或元素名称及含量标识表						
部件名称	有毒有害物质或元素					
	铅	汞	镉	六价铬	多溴联苯	多溴二苯醚
数码相机电路板元件	×	○	○	○	○	○
锂电池	×	○	○	○	○	○
交流变压器	×	○	○	○	○	○

○: 表示该有毒有害物质在该部件所有均质材料中的含量均在SJ/T 11363-2006规定的限量要求以下。
 ×: 表示该有毒有害物质至少在该部件的某一均质材料中的含量超出SJ/T 11363-2006规定的限量要求。



USB 数据线

Kodak

Eastman Kodak Company

Rochester, NY 14650

Eastman Kodak Company, 2007

Kodak, EasyShare, and Perfect Touch are trademarks of Eastman Kodak Company.

2F6825_en

www.kodak.com/go/m763support [m863support](http://www.kodak.com/go/m863support) [md863support](http://www.kodak.com/go/md863support)  29